

Securyfence

User manual

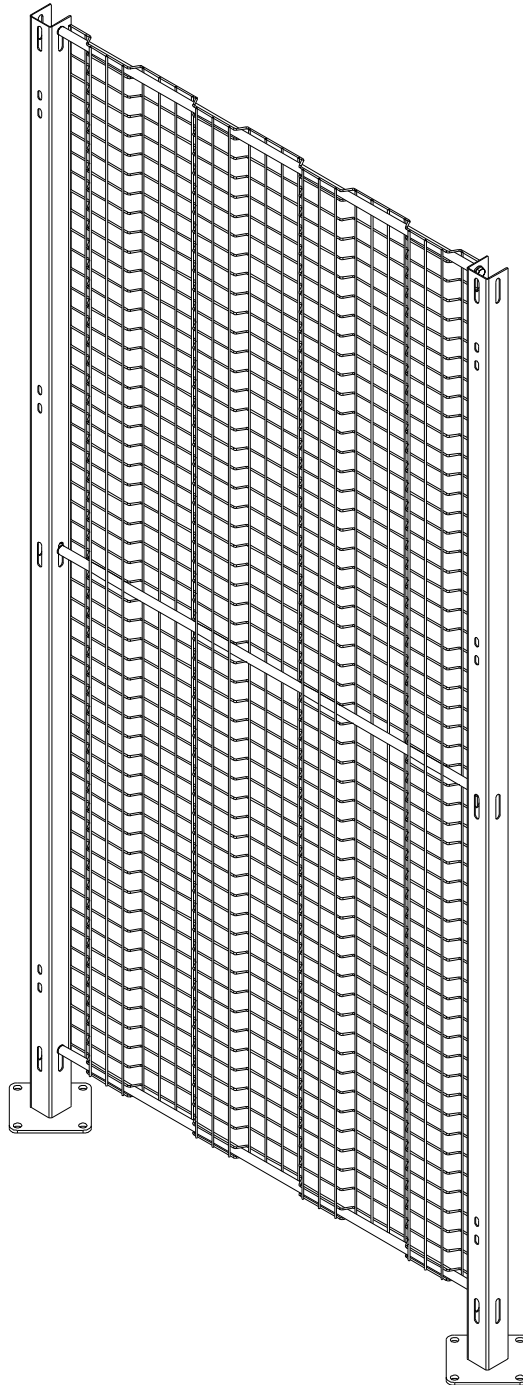

All rights reserved. No part of this publication may be reproduced, stored in a computer database or published in any form or in any way electronically, mechanically, by means of photocopying, recordings or in any manner without prior written permission.

Table of contents

1	About this manual	4
1.1	Corresponding documentation	4
1.2	Symbols used in the manual.....	4
1.3	Terminology list	4
1.4	Original user manual	4
2	General	5
2.1	Warranty.....	5
2.2	Liability	5
2.3	CE Declaration of Conformity	5
2.4	Patent	5
3	Safety.....	6
3.1	Intended use.....	6
3.2	Safety instructions.....	6
3.3	Safety equipment	7
4	Description	7
4.1	Specifications of the surrounding area	7
4.2	Overview of parts	7
5	Installation.....	8
5.1	Transport	8
5.2	Installation.....	8
6	Maintenance.....	10
6.1	Preventive maintenance schedule	10
6.2	Cleaning.....	10
6.3	Replacing parts.....	10
7	Declaration of conformity	11

1 About this manual

1.1 Corresponding documentation

Document	Reference
Manual	UM-SECURITYFENCE_V2.0-EN
Assembly instructions	AI-SECURITYFENCE_V2.0-EN
OEM parts of fencing <ul style="list-style-type: none">• Safety switch	

Manuals of the fencing and OEM parts can be found at www.securyfence.com.

1.2 Symbols used in the manual



Warning

Risk of serious injury to the user if the instructions are not accurately followed.



Note

A point of attention or hint for doing the task in a safer or more convenient way.

1.3 Terminology list

Term	Definition
components	All parts included in the Securyfence fencing.
danger	The possible source of damage within the fencing, against which the fencing has to protect
(safety) fencing	The shielding built using the components of Securyfence.

1.4 Original user manual

This is the original version of the user manual.

2 General

2.1 Warranty

The scope and duration of the warranty is agreed on ordering. The warranty applies only if the product is used according to the specifications and if the user- and maintenance instructions are observed. The warranty does not cover wear parts. The warranty is null and void in case of:

- Unskilled use.
- Inadequate maintenance.
- Unskilled maintenance.
- Changes to the machine without prior permission.

2.2 Liability

Qimarox is not liable for unsafe situations, accidents and damage resulting from:

- Ignoring warnings or rules in this manual.
- Use of the components for other applications or under other circumstances than known at the time of ordering from SecuryFence.
- Modifications of the components of any kind. This also includes use of other replacement parts than specified in this manual.
- Inadequate maintenance.

2.3 CE Declaration of Conformity

Components of Securyfence are conform the Machinery Directive 2006/42/EC. The declaration of conformity is included on page 11 of this manual.

**Note**

The declaration of conformity applies exclusively to the components of Securyfence.

**Note**

The supplied components are conform the machinery directive. Follow this manual and applicable harmonized standards to make sure the installed fencing is also conform the machinery directive.

2.4 Patent

Patent protection applies to parts of the safety fencing.

3 Safety

3.1 Intended use

The Securyfence components are to be used exclusively as fencing to prevent access to (dangerous) zones or areas. Securyfence does not provide protection to heat, radiation, sound or any other danger that can pass under, over or through the mesh of the fencing.

3.2 Safety instructions

3.2.1 General

Observe the safety regulations mentioned in this manual. Any deviations from these regulations may lead to unacceptable risks.

- Never close the door(s), if present, of the Securyfence when persons are still present within the fencing.
- Switch off the machine and secure it against switching on when carrying out activities within the fencing.
- Observe all regulations of the local laws and regulations.

3.2.2 Installation

- Do not install the fencing while the danger the fencing should be protecting from, is present.
- Install the fencing in accordance with the local laws and regulations concerning health and safety.
- Check if the fencing has been set up in accordance with the instructions in this manual.
- Activities on the electrical installation shall only be carried out by qualified personnel.
- After installation all necessary warning signs should be applied according to local laws and regulations.

3.2.3 During use

- Users must know the various safety provisions.
- If the fencing is damaged, the danger within the fencing must be stopped immediately and damaged components must be replaced.

3.2.4 Maintenance and repair

- Do not conduct maintenance or repairs while the danger inside the fencing is present.
- Replace damaged or defective parts before activating the danger inside the fencing.
- Changes and modifications that may affect the safety or integrity of the fencing shall only be carried out when these changes and modifications comply with the regulations of the applicable directives and harmonised standards.

When the changes and modifications are outside the specifications given by SecuryFence in this manual and the company has not granted permission, the changes and modifications will entirely be the responsibility of the person(s) carrying out the changes and modifications.

- Activities on the electrical installation shall only be carried out by qualified personnel.

3.2.5 Relevant harmonised standards

Below is a list of possibly relevant harmonised standards to comply to. Observe local laws and regulations for additional standards and requirements.

Number of standard	Title of standard
ISO 12100:2010	Safety of machinery – General principles for design – Risk assessment and risk reduction
EN 953:1997+A1:2009	Safety of machinery – Guards – General requirements for the design and construction of fixed and movable guards
ISO 14120:2014	Safety of machinery – Guards – General requirements for the design and construction of fixed and movable guards
ISO 13855:2010	Safety of machinery – Positioning of safeguards with respect to the approach speeds of parts of the human body
ISO 13857:2008	Safety of machinery – Safety distances to prevent hazard zones being reached by upper and lower limbs

3.3 Safety equipment

- It is not permitted to disassemble, bypass or disable any safety equipment.
- The danger inside the fencing may not be started or must be immediately taken out of operation if one of the safety provisions is defective.
- After having completed maintenance activities, always re-install all safety provisions that have been removed.

4 Description

4.1 Specifications of the surrounding area

This product must be placed indoors. This product may not be used in a potentially explosive atmosphere. Condensation may cause corrosion.

4.1.1 Specifications of Qimarox supplied safety switches

Safety switch	Allowed environmental temperature range	Protection class ¹
AZ 16 ...	-30 to 80°C	IP67
AZM 161 .../...	-25 to 60°C	IP67



Note

Consult the documentation of the safety switches for additional requirements on the surrounding area.

4.2 Overview of parts

For an overview of the parts and part numbers, consult the Assembly Instructions.

¹ IEC/EN 60529

5 Installation

5.1 Transport

By default, the Securyfence is delivered on a special transport pallet. The adjacent image illustrates where the components of the fencing are placed on this pallet.

- A. Wire mesh panels and door assemblies
- B. Columns and lintels
- C. Rods and fasteners

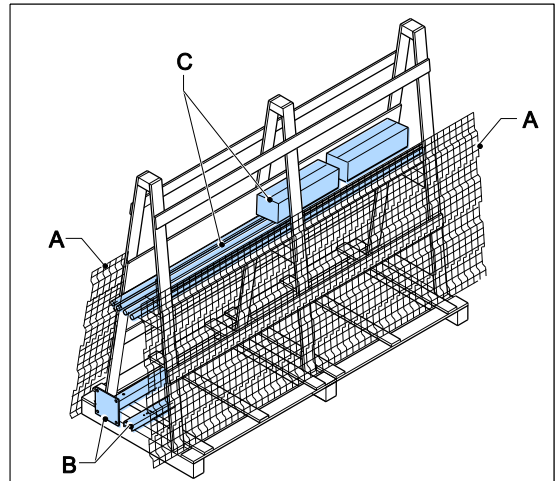

Warning

Use suitable lifting equipment to prevent the pallet from falling over.

5.2 Installation

Refer to the assembly instructions for detailed step-by-step instructions to assemble and install the safety fencing. Make sure that the various components are properly grounded to prevent electrical shocks.

5.2.1 Installing wire mesh panels and columns

Use at least three rods when installing a 2120 mm wire mesh panel and two rods when installing a 1040 mm panel. Place them in the most upper and lower position. If a wire mesh panel is cut, additional rods must be placed along the horizontal edges.



Warning

Place the wire mesh panels with the vertical wires facing outwards, to impede climbing of the fencing.

Each hole in a baseplate, with no wire mesh panel above it, should be used when fastening the column to the floor. Each column must be fixed with at least two fasteners. When installing a door, the holes in the doorway must be used as well.

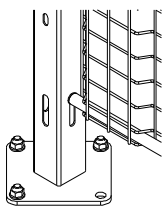

1 panel

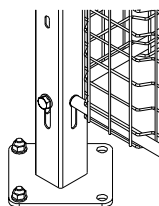

2 panels corner

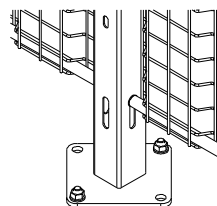

2 panels straight

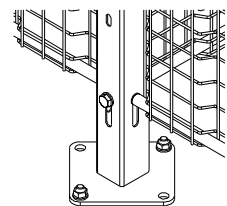

3 panels



Note

Use Fischer FBN II 10/30 bolts or equal. These are not supplied by default, but can be ordered. For the specifications of the bolts, refer to the documentation of the supplier. Use the appropriate fastener for the type of floor, other floors require different fasteners. Beware of underfloor heating.



Warning

Make sure the fasteners are securely fixed to the floor.

The following guidelines assume only people over 14 years old have access to the area where the fencing is placed. Make sure the installation complies to the harmonised standards (3.2.5). Observe local laws and regulations for additional standards and requirements.

- Due to the mesh size, the distance between the fencing and the danger should be at least 200 mm (ISO 13857 §4.2.4).
- The distance between the fencing and the floor should be smaller than 60 mm to prevent the feet from reaching under the fencing. If larger, the safety distance is 650 mm or more (ISO 13857 §4.3).
- The distance between the fencing and the floor should be smaller than 20 mm to prevent the hands from reaching under the fencing. If larger, the safety distance is 850 mm or more (ISO 13857 §4.2.4).



Note

Refer to ISO 13857 for the correct distance between the danger and the fencing in your situation.



Note

If the fenced area has to be accessed more frequent than once every three months, movable guards (e.g. doors) are required (ISO 14120 §6.4.1).

5.2.2 Customizing panels (optional)

Wire mesh panels can be cut to a custom width or height using a grinder or heavy cutting pliers. Panels should be cut parallel and adjacent to a wire.



Warning

Avoid creating sharp edges and deburr the wire mesh panel to prevent injury during installation and use of the Securyfence.

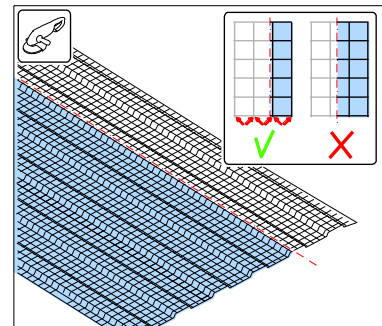

Rods can be cut to length using a grinder, metal saw or pipe cutter. The cut-off side must be equipped with a new insert, which can be ordered separately.

5.2.3 Installing doors

Doors are supplied in one piece. Single doors require a column spacing of 730 or 990 mm. As this is the same width as certain default wire mesh panels, they can be interchanged. For detailed installation instructions, follow the assembly manual and if applicable the manual of safety switches.



Note

Consult ISO 14119 and ISO 13855 to determine whether an interlock or an interlock with guard locking should be used.

**Note**

When a Slam Latch Compact is installed on a door, the Emergency Release can be used to prevent trapping inside the fenced area. Consult ISO 14120 §5.3.2 for more information.

6 Maintenance

6.1 Preventive maintenance schedule

6.1.1 Daily maintenance

Item	Task	Action when required by the check
Columns, panels and doors	Check for visible damage	Replace damaged components
Columns, panels and doors	Verify the mounting materials are present and have been correctly placed.	Place the mounting materials or correct the way in which they have been fastened.
Interlocking devices	Verify all cables are fixed	Connect the cables again
Interlocking devices	Verify functioning	Replace interlocking device

6.1.2 Monthly maintenance

Item	Task	Action when required by the check
Hinges and locks	Check for noise or heavy operation	Lubricate

6.2 Cleaning

Switch off the danger within the fencing before cleaning.

**Warning**

Do not use any corrosive and inflammable solvents or cleaning agents on the machine that contain TRI, PER, TETRA or FCHC. Read the instructions on the packaging when use is made of chemical substances (cleaning agents).

**Warning**

Electrical components should not make contact with water or other liquids.

6.3 Replacing parts

Refer to the assembly instructions to obtain the part numbers of the parts needing replacement. Parts can be ordered directly.

**Warning**

Use only replacement parts provided by Securyfence
Using parts not provided by Securyfence will void warranty.

7 Declaration of conformity

EC Declaration of Conformity of the Machinery

in accordance with Directive 2006/42/EC, Annex II, point 1.A
(Translated from Dutch)

Securyfence®

declares that the components of the Securyfence safety fencing comply with all applicable provisions of:

Machinery Directive 2006/42/EC

on condition the safety fencing is assembled and installed in accordance with the user manual.

Where applicable, the following harmonised standards are used:

ISO 12100:2010	Safety of machinery – General principles for design – Risk assessment and risk reduction
ISO 14120:2002	Safety of machinery – Guards – General requirements for the design and construction of fixed and movable guards
EN 953:1998+A1:2009	Safety of machinery – Guards – General requirements for the design and construction of fixed and movable guards

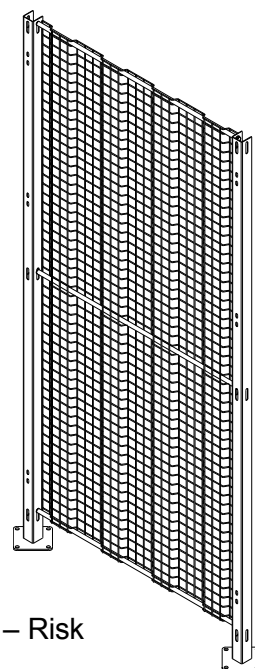

City: Harderwijk
Date: March 2014
Name: P.G. Hannessen
Function: Director

Signature: